

EMPL-G201

mPCIe to dual isolated GbE LAN Module

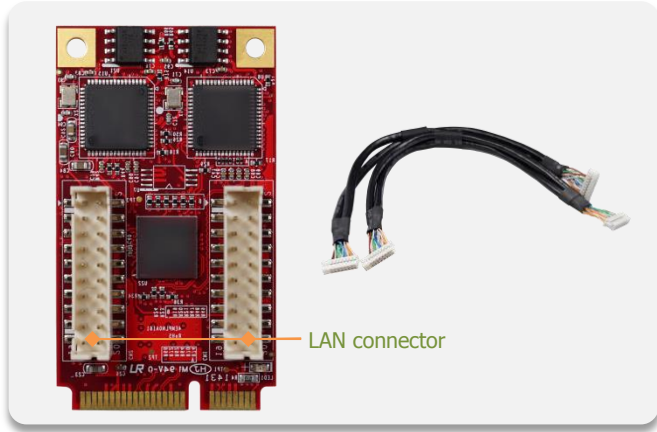

Features

- Dual isolated GbE LAN ports
- Complies with EN61000-4-5 1kV Surge protection
- Complies with IEC 60950-1:2005 + A1: 2009 + A2:2013 2kV HiPOT protection
- Complies with EN61000-4-2 (ESD) Air-15kV, Contact-8kV
- Flexible daughter board with cable to fit into different system
- Optional terminal mounting hole or bracket for daughter board
- Optional Industrial Temperature (-40°C to +85°C) support
- 30μ " golden finger, 3 years warranty
- Industrial design, manufactured in innodisk Taiwan

Mechanical Drawing

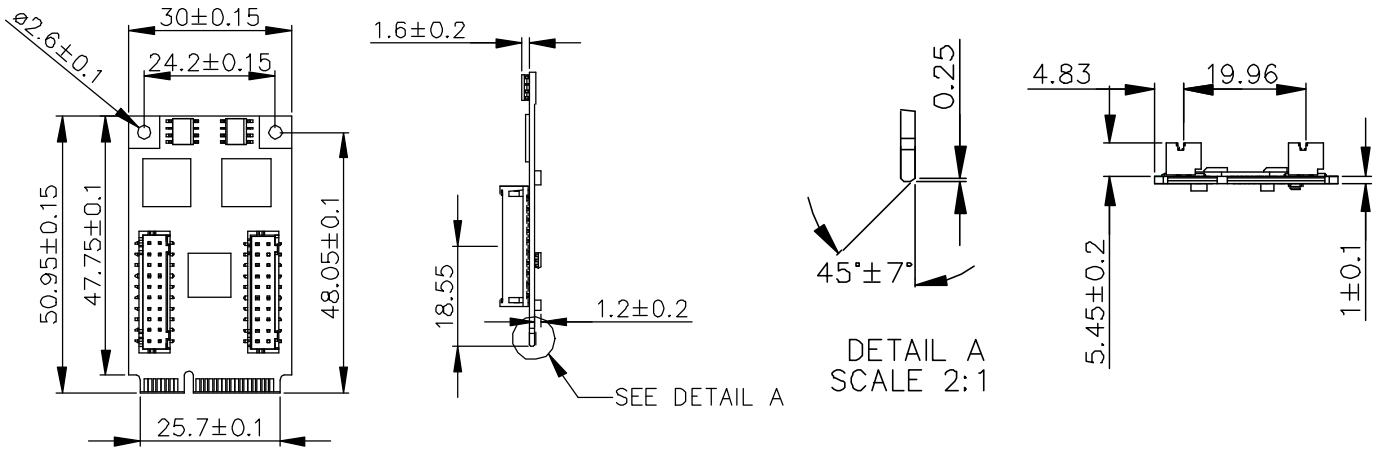

Specifications

Form-Factor	mPCIe
Input I/F	PCI Express 2.1 x 1
Output I/F	Dual GbE LAN
Output Connector	RJ45 x 2
TDP	1.485W (3.3V, 450mA)
Dimension (WxLxH)	30 x 50.9 x 6.1 mm
Temperature	Operation: STD: 0°C ~ +70°C. W/T: -40°C ~ +85°C Storage: -55°C ~ +95°C
Environment	Vibration: 5G @7~2000Hz, Shock: 50G @ 0.5ms
Notes	Please download driver from MyInnodisk website. Windows: XP(32bit), 7(32/64bit), 8/8.1(32/64 bit), 10(32/64bit) Linux: kernel 2.4 series, 2.6.x and 3.x version.

Headquarters (Taiwan)

5F., No.237, Sec. 1, Datong Rd.,
Xizhi Dist., New Taipei City 221,
Taiwan

Tel: +886-2-7703-3000
Email: sales@innodisk.com

Branch Offices:

USA

usasales@innodisk.com
+1-510-770-9421

Europe

esusales@innodisk.com
+31-040-282-1818

Japan

jpsales@innodisk.com
+81-45-594-7581

China

sales_cn@innodisk.com
+86-755-21673689

www.innodisk.com

© 2015 Innodisk Corporation.
All right reserved. Specifications
are subject to change without
prior notice.

October 22, 2015

Order information

EMPL-G201-C1 (Terminal mounting hole, Standard Temp.)

EMPL-G201-W1 (Terminal mounting hole, Wide Temp.)

EMPL-G201-C2 (Bracket, Standard Temp.)

EMPL-G201-W2 (Bracket, Wide Temp.)

mPCIe to Dual GbE LAN Module

EMPL-G201-C1/W1 Daughter Board and Mechanical Drawing

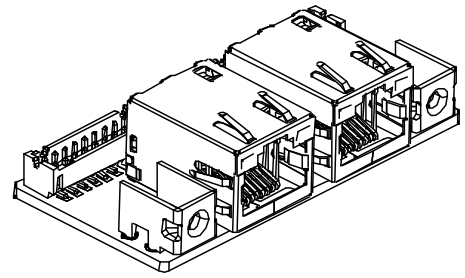

TOLERANCE: $\pm 0.20\text{mm}$

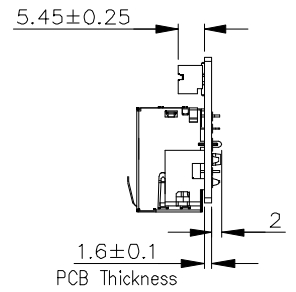
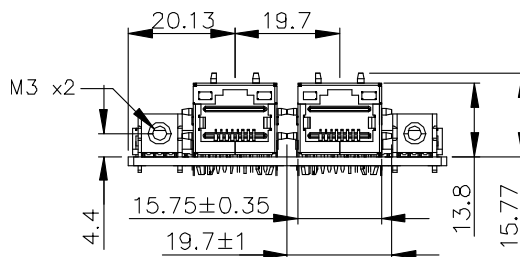
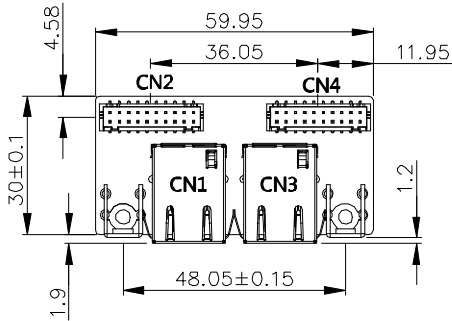

EMPL-G201-C2/W2 Daughter Board and Mechanical Drawing

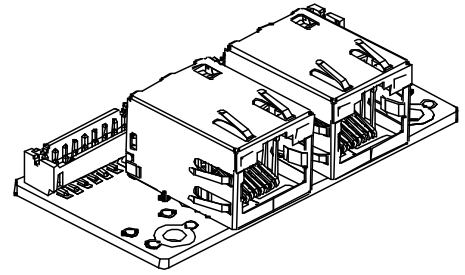
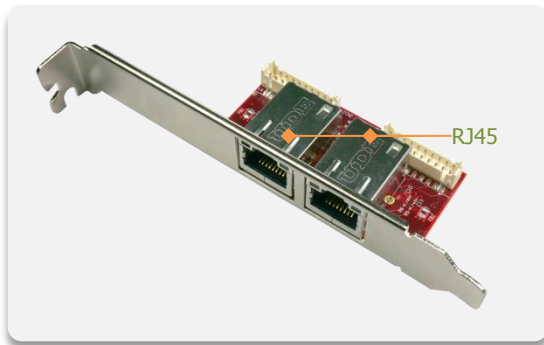

TOLERANCE: $\pm 0.20\text{mm}$

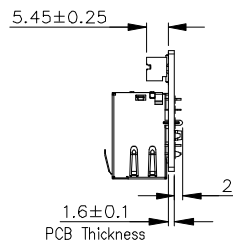
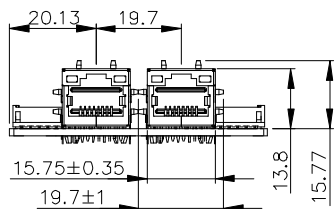
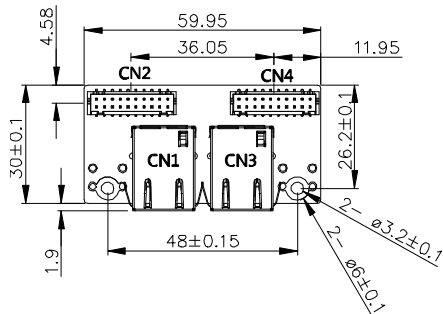

Bracket

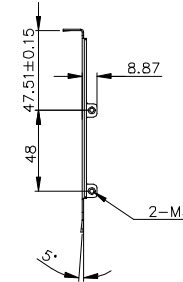
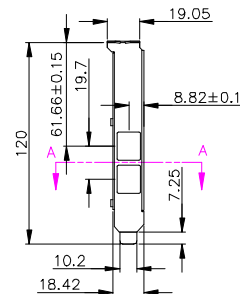
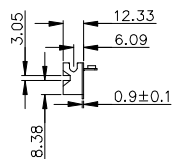
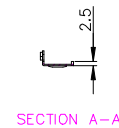
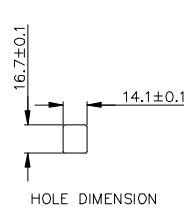

TOLERANCE: $\pm 0.20\text{mm}$